



KMP-03











Código: 0767636

Módulo horario para montaje en panel o superficie, basado en una sencilla programación diaria mediante pequeños segmentos desplazables. Es de gran utilidad en diversas aplicaciones tales como calderas, sistemas de riego...

CERTIFICACIONES



DATOS TÉCNICOS

	Alimentación: 220 – 240 V/CA, 50-60 Hz
	Programación: diaria
	Número de uñetas: 96
	Número de maniobras ON/OFF: 48 / día
	Máximo tiempo programable: 24 horas
	Mínimo tiempo programable: 15 minutos
	Capacidad de contacto: Resistiva ($\cos\phi=1$): 16 A Inductiva ($\cos\phi=0,6$): 4 A
	Reserva de marcha: no dispone
	Tª de funcionamiento: -10°C a +50°C
	Clase de protección: II
	IP20

CARACTERÍSTICAS PRINCIPALES

Módulo horario analógico mediante uñetas imperdibles
Montaje en panel o superficie
Funcionamiento por motor síncrono
Válido para interior
Conmutador manual AUTO/ON/OFF
Indicación de funcionamiento mediante manecillas de reloj

DIMENSIONES (mm)

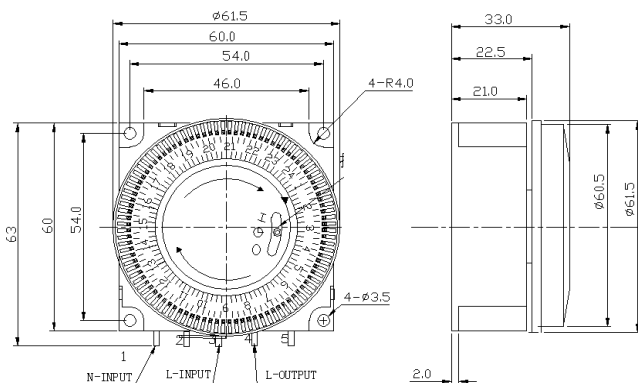

ESQUEMA DE CONEXIÓN

