



KL1





Código: 0767824

Plafón con iluminación LED. Adecuado para utilizar con funcionalidad de esclavo del plafón con detector de movimiento integrado KLD1. Permite un control eficiente de la iluminación en múltiples aplicaciones como pueden ser largos pasillos de hoteles, oficinas, hospitales...







CERTIFICACIONES



DATOS TÉCNICOS

	Alimentación: 220-240V/CA (50/60Hz)
	Altura de instalación: 2,2 m. - 4 m.
	Cargas (Máx): 20 W (120 uds. de LED SMD)
	Tª de funcionamiento: -20 °C a +40 °C
	IP20
	Nivel luminoso: 1400 lúmenes

DATOS TÉCNICOS

	Tª color: 4000 K
	Luz LED sin detector de movimiento incorporado
	
	Montaje superficial en techo/pared
	
	Válido para interior
	Sirve de esclavo del plafón con detector de movimiento KLD1

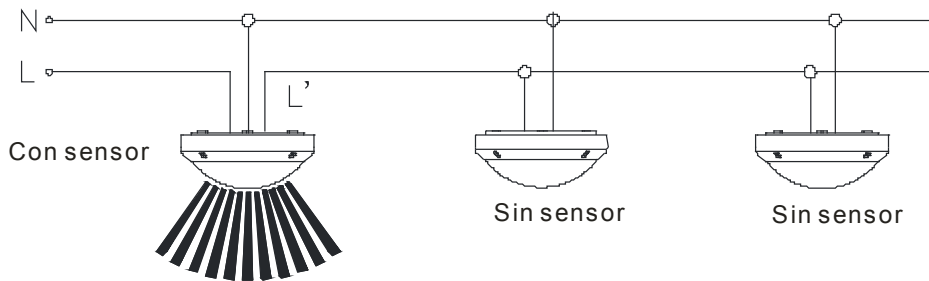

ESQUEMA DE CONEXIÓN

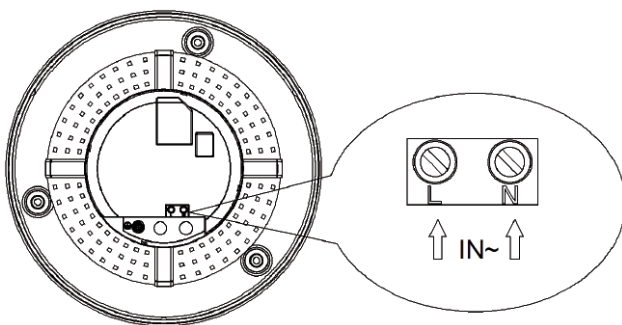

DIMENSIONES (mm)

